

INNOVATIVE FOLDING TECHNOLOGIES
YENİLİKÇİ BÜKME TEKNOLOJİLERİ

 ERBEND

INDEX

1 / PANEL BENDER COMPACT
PANEL BÜKME MAKİNELERİ

4-10 / PBC 2315

3 / SINGLE STATION SHEET METAL
FOLDING MACHINES
TEK İSTASYONLU CAKA BÜKME
MAKİNELERİ

14-15 / MFB 20-21 / MFE
16-17 / MFC 22 -24 / SFA
18-19 / MFG

5 / MANUAL SHEET METAL FOLDING
MACHINES
MANUEL CAKA BÜKME MAKİNELERİ
31-32 / UFA

2 / COMBI UP-DOWN SHEET METAL
FOLDING MACHINES
KOMBİ YUKARI AŞAĞI HAREKETLİ CAKA
BÜKME MAKİNELERİ

11-13 / DUAL MFA

4 / COMBI SHEET METAL FOLDING
MACHINES
KOMBİ CAKA BÜKME MAKİNELERİ

25-27 / MFA
28-30 / MFD

6 / MOTORIZED SHEARS
REDÜKTÖRLÜ MAKASLAR

33-34 / EMS
35-37 / ERFOLD



All the product photos in this catalogue are representative and may not have exactly the same appearance and features as the machines to be produced later. Erbend reserves the right to make all kinds of changes in the appearance and features of its products without prior notice.

Bu katalogda yer alan fotoğrafların tamamı temsilidir ve yeni üretilen makinele birebir aynı görünümde ve özelliklerde olmayabilir. Erbend, makine görünümünde ve özelliklerinde haber vermeksizin değişiklik yapma hakkını saklı tutar.

ERBEND is a registered trademark. In case of any unauthorized use of this trademark, logo or visuals, ERBEND may constitute trademark infringement and unfair competition in violation of laws.

Erbend tescilli bir markadır. Bu içerikteki marka, logo ve görsellerin izinsiz kullanımı halinde tüm yasal haklarımız saklıdır.

ERBEND Makine, which is one of the few manufacturers in the world of "folding machine" models that bend metal sheets by folding method, includes automatic panel bending machines and guillotine shears in its product portfolio.

Erbend Makine, which has **30 years** of machine industry and experience, shows its difference and assertiveness in the sector with its aim of "Innovative Bending Technologies" and continues its activities in Bursa with its expert staff in its production facilities with a closed area of **5,000 m²**.

ERBEND Makine, which operates machines in more than **50 countries**, among them the United States, Canada, Sweden, Germany, Russia and Australia, exports 85 percent of its production.

ERBEND offers solutions to its customers for high quality production in many fields such as roof accessories, suspended ceiling systems, building facade cladding, professional kitchen equipment, heating - cooling - ventilation systems (HVAC), door - window bodies and frames, elevator and escalator systems, furniture and shelf systems.

Erbend is preferred with its customer-oriented approach.

Erbend Makine, which provides solutions according to needs with its special design capability, also provides on-site installation, training and after-sales technical support services to its customers and dealers with its technical service.

Metal sacların bükümünü katlama yöntemiyle yapan "caka bükme makine" modellerinin dünyadaki sayılı üreticilerinden biri olan **ERBEND Makine** ürün portföyünde ayrıca otomatik panel bükme makineleri ve giyotin makaslar yer alıyor.

30 yıllık makine sektör tecrübesine sahip Erbend Makine "Yenilikçi Bükme Teknolojileri" anlayışıyla sektörde farkını ve iddiasını gösterirken alanında uzman kadrosu ile Bursa'da **5.000 m²** kapalı alana sahip üretim tesislerinde faaliyetlerini sürdürüyor.

Aralarında Amerika Birleşik Devletleri, Kanada, İsveç, Almanya, Rusya ve Avustralya başta olmak üzere **50'iyi aşkın ülkede** makineleri çalışan ERBEND Makine üretiminin yüzde 85'ini ihraç etmektedir.

Çatı aksesuarları ve bina cephe giydirmeleri, asma tavan sistemleri, profesyonel mutfak ekipmanları, ısıtma - soğutma - havalandırma sistemleri (HVAC), kapı - pencere gövde ve çerçeveleri yanında asansör ve yürüyen merdiven sistemleri ve mobilya ve raf sistemleri gibi pek çok alanda müşterilerine yüksek kaliteli üretim için çözümler sunan **ERBEND Makine** müşteri odaklı yaklaşımı ile tercih ediliyor.

Özel tasarım kabiliyeti ile ihtiyaca göre çözümler sağlayan **Erbend Makine** teknik servisi ile müşteri ve bayilerine yerlerinde kurulum, eğitim ve satış sonrası teknik destek hizmetleri de sunmaktadır.





DUAL MFA

Cnc Servo Up-Down Sheet Metal Folding Machine
Cnc Servo Yukarı - Aşağı Hareketli Caka Bükme Makinesi



MFB

CNC Motorized Sheet Metal Folding Machine
CNC Motorlu Caka Bükme Makinesi



MFC

CNC Motorized Sheet Metal Folding Machine
CNC Motorlu Caka Bükme Makinesi



MFG

CNC Motorized Sheet Metal Folding Machine
CNC Motorlu Caka Bükme Makinesi



MFE

CNC Servo Sheet Metal Folding Machine
CNC Servo Caka Bükme Makinesi



PBC 2315

Panel Bender Compact - Automatic
Panel Bükme Kompakt - Otomatik



SFA

CNC Servo Sheet Metal Folding Machine
CNC Servo Caka Bükme Makinesi



MFA

CNC Servo Combi Sheet Metal Folding Machine
CNC Servo Kombi Caka Bükme Makinesi



MFD

CNC Servo Combi Sheet Metal Folding Machine
CNC Servo Kombi Caka Bükme Makinesi



DUAL MFA

CNC Servo Up-Down Sheet Metal Folding Machine
CNC Servo Yukarı - Aşağı Hareketli Caka Bükme Makinesi

PBC 2315

Panel Bender Compact – Automatic
Panel Bükme Kompakt – Otomatik

Büküm Örnekleri

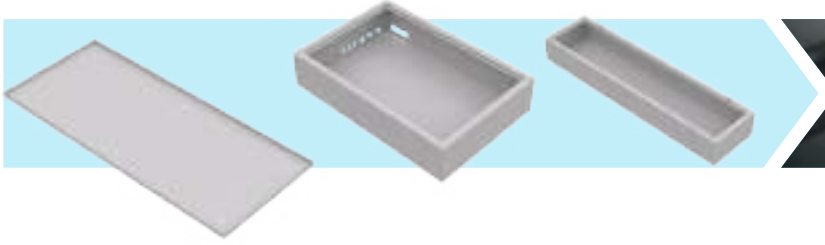

Stainless Furniture & Trims

Paslanmaz Mobilya & Döşemeler
ve Raf Sistemleri



Panels

Paneller

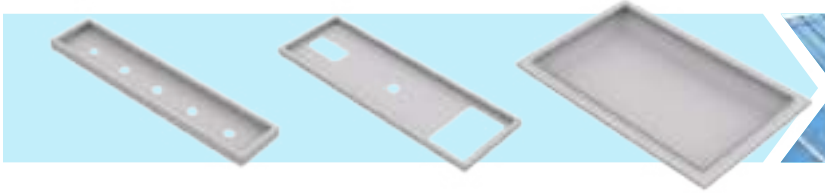

Architectural Metal Trims

Metal mimari ve aydınlatma
ürünleri

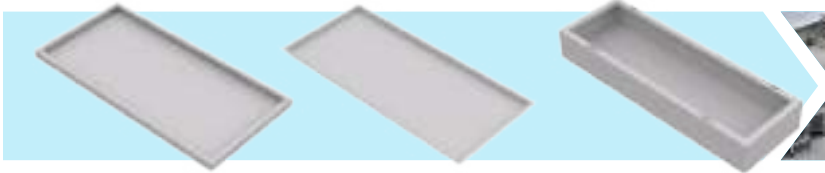

Professional Kitchen Equipment

Profesyonel mutfak ekipmanları



Electrical Cabinets and Boxes

Pano ve Kabinler



— Meet with innovative bending technologies, make a difference with modern production...

ERBEND, which has developed its expertise in the production of folding bending machines with R & D studies, with its new Panel Folding Machine model Panel Bender Compact PBC 2315

- Stainless furniture, flooring and shelf systems
- Panels
- Metal architecture and lighting products
- Professional kitchen equipment
- It offers fast, economical and user-friendly solutions to many sectors, especially panels and cabins.

In the automatic panel bending machine model PBC 2315, designed for bending sheet metal plates of all thicknesses between 0.3 mm and 2 mm, the manipulator automatically rotates the workpiece by moving. The bending unit bends the part coming to the bending axis upwards and downwards. PBC 2315 has a working length between min 400 mm and max 2300 mm.

— Yenilikçi bükme teknolojileri ile tanışın, modern üretimle fark yaratın...

Caka büküm makineleri üretimindeki uzmanlığını Ar-Ge çalışmaları ile geliştiren ERBEND yeni Panel Bükme Makine modeli Panel Bender Kompakt PBC 2315 ile

- Paslanmaz mobilya, döşemeler ve raf sistemleri
- Paneller
- Metal mimari ve aydınlatma ürünleri
- Profesyonel mutfak ekipmanları
- Pano ve kabinler başta olmak üzere bir çok sektöre hızlı, ekonomik ve kullanıcı dostu çözümler sunuyor.

0,3 mm ile 2 mm arasında tüm kalınlıklardaki sac plakaların bükümü için tasarlanmış otomatik panel bükme makine modeli PBC 2315'de manipölatör hareket ederek işlenecek parçayı otomatik olarak döndürür. Büküm eksenine gelen parçayı bükme ünitesi ise yukarı ve aşağı doğru bükür. PBC 2315 min 400 mm ile max 2300 mm arasında çalışma boyuna sahiptir.

PBC 2315

Panel Bender Compact – Automatic
Panel Bükme Kompakt – Otomatik

CNC CONTROL SYSTEM

- In ERFOLD CNC control system, each side bend is programmed individually and profile view of the side is shown on the screen after each bend is programmed.
- Each process type on the sides (normal bend, hemming, large radius etc.) is defined, and bending/process length is entered numerically.
- After bending measures are defined, sheet's rotation direction is determined as rotate +90° or rotate -90° or rotate 180°
- Step by step numerical programming is advantageous because you can intervene to any bend or movement step freely regarding the reaction of the sheet or geometry of the final part.

CNC KONTROL SİSTEMİ

- ERFOLD CNC kontrol sisteminde, her bir kenar ayrı ayrı programlanır ve nümerik olarak programlanan kenarın yandan kesit görünümü ekranda gösterilir.
- Her bir kenardaki büküm tipi (normal büküm, kenar ezme, geniş radüs, sıralı radüs vb) seçilir, büküm uzunluğu nümerik olarak girilir
- Her bir kenarın büküm dizaynı yapıldıktan sonra, sacın hangi yöne doğru çevirileceği veya önce kaldırılıp sonra çevirileceği gibi hareket değerleri de nümerik olarak programlanır.

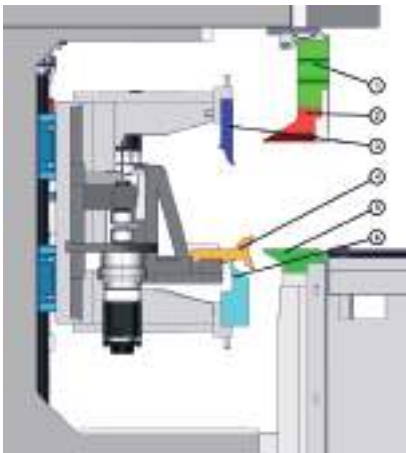

MACHINE BENDING GROUP LAYOUT

- 1) UPPER BEAM TOOLS PNEUMATIC CLAMPS
- 2) UPPER BEAM TOOLS
- 3) UPPER BENDING TOOL
- 4) GAUGING AND SEGMENTED BENDING TOOLS
- 5) BOTTOM TOOL
- 6) LOWER BENDING TOOL

MAKİNE YAPISI VE BÖLÜMLERİ

- 1) PNÖMATİK SIKMA ÜST BASKI KALIPLARI
- 2) PNÖMATİK SIKMA AÇILIR ÜST KALIP
- 3) ÜST BÜKME KALIBI
- 4) PARÇALI ALT ÜST BÜKME KALIBI VE DAYAMA
- 5) ALT KALIP
- 6) ALT BÜKME KALIBI



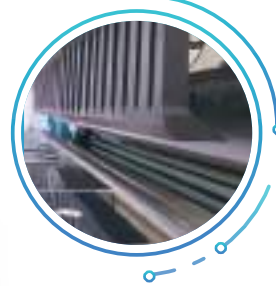

Pneumatic Manipulator
Pnömatik Manipulätör

BENDING TYPES BÜKÜM TIPLERİ

DOWN BENDINGS AŞAĞI YÖNLÜ BÜKÜMLER



Auxiliary Tool Down Bending 01
Yardımcı Kalıp Aşağı Yönlü Büküm 01



Auxiliary Tool Down_Bending 02
Yardımcı Kalıp Aşağı Yönlü Büküm 02



Counter Hemming 01
Ters Ezme 01



Counter Hemming 02
Ters Ezme 02



Downward Bend
Aşağı Yönlü Büküm



Downwards Radius Bending
Aşağı Yönlü Radüs Büküm

UP BENDINGS YUKARI YÖNLÜ BÜKÜMLER



Auxiliary Tool Down Bending 01
Yardımcı Kalıp Aşağı Yönlü Büküm 01



Auxiliary Tool Upward Bending 02
Yardımcı Kalıp Yukarı Yönlü Büküm 02



Flat Hemming 01
Düz Ezme 01



Flat Hemming 02
Düz Ezme 02



Open Hemming
Açık Ezme



Upward Bend
Yukarı Yönlü Büküm



Upwards Radius Bending
Yukarı Yönlü Radüs Büküm



Auxiliary Tools / Yardımcı Kalıplar



Vacuum Table / Vakum Tutucu Tabla

More production in less time...

Daha kısa sürede, daha fazla üretim...



PBC 2315

Panel Bending Compact Panel Bükme Makinesi

TECHNICAL PARAMETERS / TEKNİK PARAMETRELER VE ÖZELLİKLER

Bending length / Büküm genişliği	mm	2300	
Max plate length / Plaka max genişliği	mm	2300	
Max plate width / Plaka max derinliği	mm	1500	
Max bending height/depth Büküm derinliği/yüksekliği	mm	254	
Min Bending Size (Four side) / Min Büküm Ölçüsü (Dört kenar)	mm	410 x 410	
Min Bending Size (One side) Min Büküm Ölçüsü (Tek kenar)	mm	210	
Bending speed / Büküm Hızı	sec/sn	0.5	
Clamping beam opening height Baskı çene açılma yüksekliği	mm	265	
Max bending angle Maksimum büküm açısı	°	+/- 145°	
Max material thickness Malzeme büküm kalınlığı	mm	Mild Steel / Karbon Çeliği : 1.5	
		Stainless / Paslanmaz: 1	
		Aluminium / Alüminyum: 2	
Controller Software / Kontrol Sistemi		ERFOLD	
Operating System İşletim Sistemi	OS	Windows	
Number of Axis / Eksen Sayısı	pc/adet	11	
Machine Dimensions Makine Ölçüleri	Length / Uzunluk	mm	5000
	Width / Genişlik	mm	3915
	Height / Yükseklik	mm	2850
Machine Weight / Makine Ağırlığı	kg	15000	

CNC Servo Combi Up-Down Sheet Metal Folding Machine CNC Servo Kombi Yukarı – Aşağı Hareketli Caka Bükme Makinesi

Dual MFA

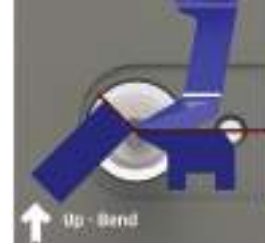
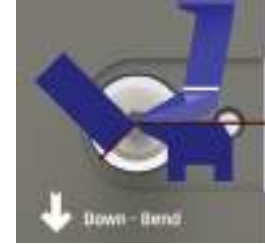

- With Erbend Up-Down Moving Folding models, folding (bending) solutions with various features from the easiest to the most complex...

You can make fast, efficient, precise and safe production with the Dual Series, which are produced as Single Station Up-Down Moving Folding Machine models and Combi Up-Down Moving Folding Machine models

- Erbend Yukarı Aşağı Hareketli Caka Bükme modelleri ile en kolayından en karmaşığına kadar çeşitli özelliklerde katlama (bükme) çözümleri...

Tek İstasyonlu Yukarı Aşağı Hareketli Caka Bükme Makine modelleri ve Kombi Yukarı Aşağı Hareketli Caka Bükme Makine modelleri olarak üretilen Dual Serisi ile hızlı, verimli, hassas ve güvenli üretim yapabilirsiniz.



DOWN BEND / AŞAĞI YÖNLÜ BÜKÜM



UP BEND / YUKARI YÖNLÜ BÜKÜM



Dual MFA

CNC Servo Combi Up-Down Sheet Metal Folding Machine CNC Servo Kombi Yukarı - Aşağı Hareketli Caka Bükme Makinesi

STANDARD FEATURES

- Thanks to the up&down bending function there is no need to flip the sheet for down bends
- Thanks to A and B axis, pivot center of the bending is adjusted automatically for both up and down bends
- Dual motorized driven upper beam for better clamping and hemming operations
- 125 mm high segmented goat foot tools and 30° single piece sharpnose tool on the 180° rotating upper beam with two tooling stations and 250 mm opening height.
- Single piece lower beam tool with gauging finger channels
- 2 sets of single piece folding beam tools as 15 and 40 mm wide.
- Erfold 3D Dual cnc controller software on 22" touchscreen with swivel arm
- Servo backgauge system with solid fingers and 1500/750/1500 mm U shape sheet support table with stainless ball transfers
- Front light barriers
- 2 foot pedals for front and rear operation

STANDART ÖZELLİKLER

- Yukarı ve aşağı (Up&Down) yönlü büküm yeteneği ile büküm operasyonları sırasında sacın ters çevrilme ihtiyacı ortadan kaldırılması.
- Yukarı ve aşağı yönlü bükümlerde pivot merkezinin otomatik pozisyonlanması sağlanması.
- Daha yüksek klemplleme kuvveti için çift motorlu kontrol ve vidalı mil sistemi.
- 250mm açılma mesafeli 180° dönebilen çift kalıp istasyonlu kenetleme çenesi üzerinde 125mm yüksek parçalı keçi ayağı kalıpları ve 30° kısa keskin burun kalıp.
- Kanallı tek parça alt kalıp
- 2 set olarak 15 + 40mm genişliğin parçalı bükme kalıpları.
- 22" mafsallı kol ve dokunmatik ekran.
- Servo arka dayama sistemi ve solid dayama kolları ile 1500/750/1500 mm U şekilli, kayar bilyalı sac destek tablası.
- Ön ışık bariyeri.
- Ön ve arkada 2 adet ayak pedali

ROTATING COMBI UPPER BEAM GROUP
DÖNERLİ ÜST TABLA GRUBU

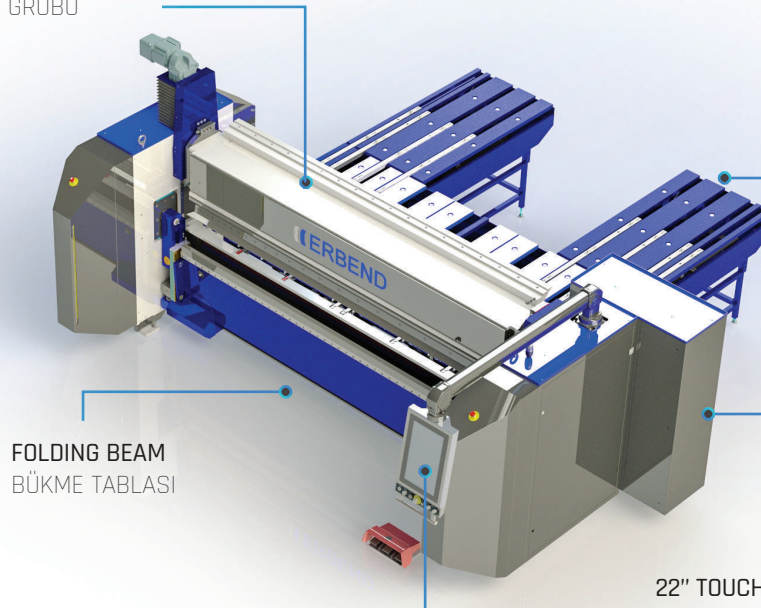

BACKGAUGE TABLE GROUP WITH SUCTION CUPS
VAKUMLU DAYAMA GRUBU

ELECTRICAL CABINET
ELEKTRİK PANOSU

FOLDING BEAM
BÜKME TABLASI

22" TOUCHSCREEN CONTROLLER
22" DOKUNMATİK EKRAN



1



1



2



2

Model Model	Folding Length (mm) Sac Geniřlięi (mm)	Steel (mm) Çelik (mm)	Stainless (mm) Paslanmaz (mm)	Aluminium (mm) Alüminyum (mm)	Std machine loading dimensions (L/W/H) / Std makine yükleme ölçüleri G / U / Y	Weight (kg) Aęırık (kg)
DUAL MFA 2535	2550	3,5	2,5	5	4500/4600/2300	7600
DUAL MFA 3230	3200	3	2	4	5100/4600/2300	8550
DUAL MFA 4225	4200	2,5	1,5	3,5	6100/4600/2300	9950

STANDARD FEATURES

- 220 mm opening height capacity on the upper beam.
- Eccentric upper beam power transmission system for rapid clamping/ unclamping.
- 1000 mm servo backgauge system with feather grooves.
- Manual folding beam adjustment.
- 10 and 25 mm wide single piece folding tools as 2 sets.
- Solid lower beam tool without channels.
- ERFOLD BASIC CNC LBL Cnc control software on 15.6 " touchscreen controller with swivel arm.
- Front light barriers.

STANDART ÖZELLİKLER

- 220mm açılma mesafeli kenetleme çenesi.
- Seri açma ve kapama için eksantrik üst çene güç aktarım sistemi.
- 1000 mm servo arka dayama sistemi ve spatula tipi dayama kolları.
- Manuel büküm çenesi yükseklik ayarı.
- 10 ve 25 mm genişlikte tek parça bükme kalıpları. (2 set)
- Tek parça kanalsız alt kalıp.
- 15.6" mafsallı kol ve dokunmatik ekran üzerinde ERFOLD BASIC CNC LBL Cnc kontrol yazılımı.
- Spatula tipi dayama kolları ve kanalsız alt kalıp.
- Ön ışık bariyerleri.

OPTIONAL FEATURES

- 1500 mm servo backgauge system with rectangular sheet support table.
- 2500 / 3200 / 4200 mm servo backgauge system upgrade with L / T / U shape sheet support table options.
- ERFOLD ADVANCED 2D/3D CNC Graphic Control Software.
- Servo folding beam adjustment.
- Manual crowning system.
- 90 or 110 mm high segmented goat foot tool set.
- Omega geometry upgrade on lower and folding beam.
- Manual conical backgauge finger.
- Motorized conical backgauge system.
- Pneumatic goat foot tool quick clamping system.

OPSİYONEL ÖZELLİKLER

- 1500 mm servo arka dayama ve dikdörtgen sac destek tablası.
- 2500 / 3200 / 4200 mm uzunlukta L / T / U şekilli sac tablalı arka dayama yükseltme. ERFOLD ADVANCED 2D/3D Cnc Grafik Kontrol.
- Servo motorlu büküm çenesi yükseklik ayarı.
- Manuel bombeleme sistemi.
- 90 veya 110 mm yükseklikte parçalı keçi ayağı kalıp seti.
- Alt çene ve bükme çenesi omega geometri yükseltmesi.
- Manuel konik arka dayama kolu. Motorlu konik arka dayama sistemi. Pnömatik keçi ayağı kalıpları hızlı sıkma sistemi

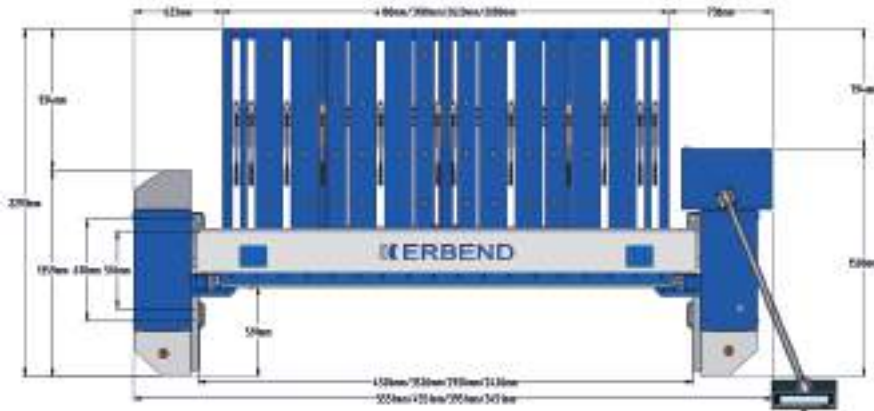

You can bend with the electric conical back gauge the profiles that can be inserted into each other.

Elektrikli konik arka dayama ile birbiri içine sokulabilen profilleri bükebilirsiniz.

Model Model	Folding Length (mm) Sac Geniřliđi (mm)	Steel (mm) Çelik (mm)	Stainless (mm) Paslanmaz (mm)	Aluminium (mm) Alüminyum (mm)	Std machine loading dimensions (L/W/H) / Std makine yükleme ölçüleri G / U / Y	Weight (kg) Ađırlık (kg)
MFB 2030	2050	3	2	4	3350/2200/1900	3800
MFB 2525	2550	2.5	1.5	3.5	3830/2200/1900	4500
MFB 3220	3200	2	1.2	3	4450/2200/1900	4500
MFB 4215	4200	1.5	1	2	5450/2200/1900	5350

STANDARD FEATURES

- 180 mm opening height capacity on the upper beam.
- Eccentric upper beam power transmission system for rapid clamping/ unclamping.
- 0 and 25 mm wide single piece folding tools as 2 sets.
- ERFOLD BASIC CNC LBL Cnc control software on 15.6 " touchscreen controller with swivel arm.
- 750 mm servo backgauge system with feather grooves.
- 0-150° folding angle.
- Manual folding beam adjustment.
- Front light barriers.
- Solid lower beam tool without channels.

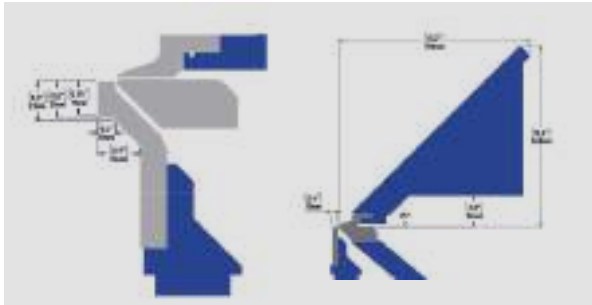

Omega geometry of lower and folding beam lets you produce omega/trapezoidal profiles.

Omega geometrilii alt ve bükme çenesi size omega/trapez tipteki parçaların bükümü için olarak sağlar.

OPTIONAL FEATURES

- 1000 or 1500 mm servo backgauge system with rectangular sheet support table.
- 60 or 90 mm high segmented goat foot tool set.
- Manual crowning system.
- Servo folding beam adjustment.
- ERFOLD ADVANCED 2D/3D Cnc Graphic Control Software.
- Omega geometry upgrade on lower and folding beam.
- Manual conical backgauge finger.
- Motorized conical backgauge system.
- Pneumatic goat foot tool quick clamping system.

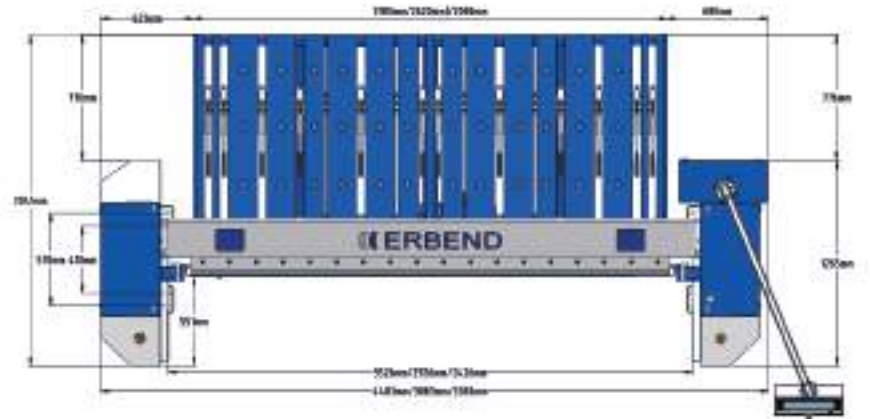



STANDART ÖZELLİKLER

- 180mm açılma mesafeli kenetleme çenesi.
- Seri açma ve kapama için eksantrik üst çene güç aktarım sistemi.
- 10 ve 25 mm genişlikte tek parça bükme kalıpları (2 set).
- 15,6" dokunmatik ekran üzerinde ERFOLD BASIC CNC LBL Cnc yazılımı ile tüm eksenlerin kontrolü.
- 750 mm servo arka dayama sistemi ve spatula tipi dayama kolları.
- 0-150° hareketli büküm çenesi.
- Manuel büküm çenesi yükseklik ayarı.
- Ön ışık bariyeri.
- Tek parça kanalsız alt kalıp.

OPSİYONEL ÖZELLİKLER

- 1000 veya 1500 mm servo arka dayama ve dikdörtgen sac destek tablası.
- 60 veya 90 mm yükseklikte parçalı keçi ayağı kalıp seti.
- Manuel bombeleme sistemi.
- Servo motorlu büküm çenesi yükseklik ayarı.
- ERFOLD ADVANCED 2D/3D Cnc Grafik Kontrol.
- Alt çene ve bükme çenesi omega geometri yükseltmesi.
- Manuel konik arka dayama kolu.
- Motorlu konik arka dayama sistemi.
- Pnömatik keçi ayağı kalıpları hızlı sıkma sistemi.

Model Model	Folding Length (mm) Sac Geniřliđi (mm)	Steel (mm) Çelik (mm)	Stainless (mm) Paslanmaz (mm)	Aluminium (mm) Alüminyum (mm)	Std machine loading dimensions (L/W/H) / Std makine yükleme ölçüleri G / U / Y	Weight (kg) Ağırlık (kg)
MFC 2025	2050	2.5	1.5	3.5	3350 / 2100 / 1860	6800
MFC 2520	2550	2	1.2	3	3830 / 2100 / 1860	3000
MFC 3215	3200	1.5	1	2	4450 / 2100 / 1860	3300

STANDARD FEATURES

- 750 mm servo backgauge with feather fingers
- Erfold basic cnc LBL software on 15" touchscreen controller
- 20°/R1 sharpnose tool on clamping beam
- 10 and 25 mm wide folding tools as 2 sets
- Solid lower beam without channels
- Manual folding beam adjustment
- Vertical front light barriers

OPTIONAL FEATURES

- 1000 mm servo backgauge system with feather fingers
- Different radius sharpnose tool
- Erfold Advanced 2D cnc graphical software

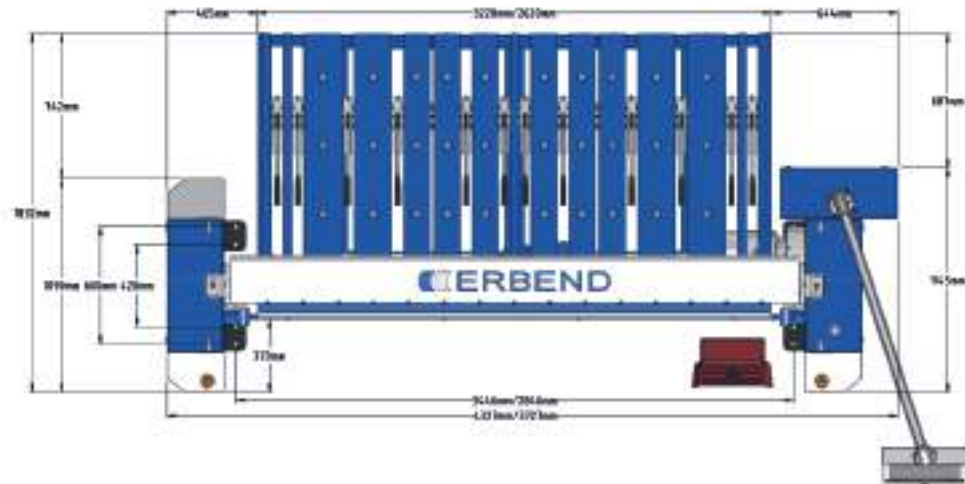



Very fast clamping and folding.

Çok hızlı büküm ihtiyacı olan üreticiler için ideal.

STANDART ÖZELLİKLER

- 750 mm servo arka dayama ve spatula dayama kolları
- Erfold Basic cnc satır programlamalı kontrol yazılımı ve 15" dokunmatik ekran kontrol ünitesi
- Üst çenede 20°/R1 tek parça keskin burun kalıp 10 ve 25 mm tek parça bükme kalıpları 2 set
- Tek parça kanalsız alt kalıp
- Manuel büküm çenesi yükseklik ayarı
- Dikey ön ışık bariyerleri

OPSİYONEL ÖZELLİKLER

- 1000 mm servo arka dayama ve spatula dayama kolları
- Farklı radüslü keskin burun kalıp
- Erfold Advanced 2D cnc grafik kontrol yazılımı

Model Model	Folding Length (mm) Sac Genişliği (mm)	Steel (mm) Çelik (mm)	Stainless (mm) Paslanmaz (mm)	Aluminium (mm) Alüminyum (mm)	Std machine loading dimensions (L/W/H) / Std makine yükleme ölçüleri G / U / Y	Weight (kg) Ağırlık (kg)
MFG 2515	2550	1.5	1	2	2100/3800/1650	2500
MFG 3210	3200	1	0.6	1.5	2100/4500/1650	2900



STANDARD FEATURES

- Clamping beam with 200 mm opening height and dual servo driven ballscrew spindle system.
- 30° single piece sharpnose tool.
- 15 and 40 mm wide folding beam tools, single piece as 2 sets
- Bottom beam tool with channels and two sets of single piece folding tools.
- 2 sets of single piece folding tools as 15 and 40 mm wide.
- Manual folding beam adjustment.
- ERFOLD BASIC CNC LBL control software on 15.6 " touchscreen controller with swivel arm.
- 1000 mm servo backgauge system with rectangular sheet support table and solid fingers.
- Front light barriers.

OPTIONAL FEATURES

- 2500 / 3200 / 4200 mm servo backgauge system upgrade with L / T / U shape sheet support table options
- ERFOLD ADVANCED 2D/3D CNC Graphic Control Software.
- Servo folding beam adjustment.
- Manual crowning system.
- Pneumatic quick goatfoot tool clamping.
- Segmented bottom or folding tools.
- 100 mm high segmented goat foot tool set.

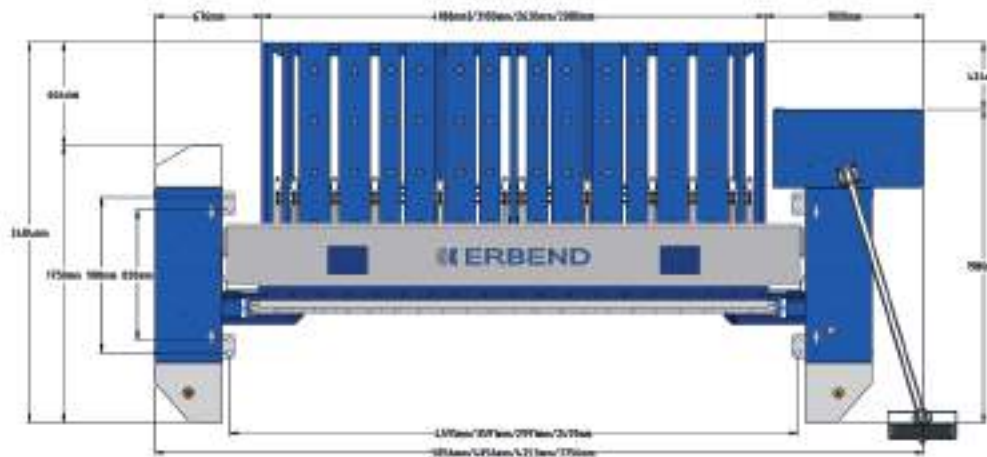

STANDART ÖZELLİKLER

- 200 mm açılma mesafeli, çift motor tahrikli ve vidalı milli üst çene.
- 30° tek parça keskin burun kalıp.
- 15 ve 40 mm genişlikte tek parça bükme kalıpları. (2 set)
- Kanallı tek parça alt kalıp ve iki set tek parça bükme kalıpları.
- 2 set olarak 15 + 40 mm genişliğinde tek parça bükme kalıpları.
- Manuel büküm çenesi yükseklik ayarı.
- 15.6" mafsallı kol ve dokunmatik ekran üzerinde ERFOLD BASIC CNC LBL cnc kontrol yazılımı.
- 1000 mm servo arka dayama sistemi, dikdörtgen sac destek tablası ve solid dayama kolları.
- Ön Işık bariyerleri.



4 mm folding capacity on full length.
Tam boyda 4 mm büküm kapasitesi.



Perfect open or drop hammering operations can be executed up to 2 mm thickness.

2 mm e varan kalınlıklarda mükemmel açık veya kapalı kenar ezme sonuçlarına ulaşılabilir.



Thanks to its dual motor driven upper beam and folding beam, a huge clamping and folding force is obtained to make 4 mm thick plate folding.

Çift motor tahrikli üst ve bükme çeneleri sayesinde elde edilen yüksek klempleme ve büküm gücü ile 4 mm kalınlığa kadar saclar rahatlıkla bükülebilir.

Model Model	Folding Length (mm) Sac Geniřliđi (mm)	Steel (mm) Çelik (mm)	Stainless (mm) Paslanmaz (mm)	Aluminium (mm) Alüminyum (mm)	Std machine loading dimensions (L/W/H) / Std makine yükleme ölçüleri G / U / Y	Weight (kg) Ağırlık (kg)
MFE 2050	2050	5	3.5	6.5	3600/2300/2000	4900
MFE 2545	2550	4.5	2.5	6	4100/2300/2000	5400
MFE 3240	3200	4	2.5	5	4700/2300/2000	6700
MFE 4230	4200	3	2	4	5700/2300/2000	8050

STANDARD FEATURES

- Clamping beam with 350 mm opening height and 170 mm high, segmented goat foot tools.
- Dual drive clamping beam with ball screw spindle system for more clamping power.
- 1500 mm servo backgauge system with rectangular sheet support table and solid fingers.
- 170 mm high segmented goat foot tools.
- ERFOLD BASIC CNC LBL control software on 15.6 " touchscreen controller with swivel arm.
- 15 and 40 mm wide folding beam tools, single piece as 2 sets.
- Manual folding beam adjustment.
- Front light barriers.

OPTIONAL FEATURES

- 400 mm clamping beam opening and 200 mm high tools upgrade.
- 2500 / 3200 / 4200 mm servo backgauge system upgrade with L / T / U shape sheet support table options.
- ERFOLD ADVANCED 2D/3D CNC Graphic Control Software.
- Motorized folding beam adjustment.
- Pneumatic goat foot quick clamping.
- Manual crowning system.
- Feather grooves with solid lower beam tool without channels.
- Segmented bottom or folding beam tools.

Bending up to 200 mm deep boxes.
200 mm derinliğe kadar kutu bükümü.



Very ideal for fabrication of box/pan parts up to 3 mm.
3 mm kalınlığa kadar olan kutu/tava tipi endüstriyel ürünlerinin bükümü için çok ideal.

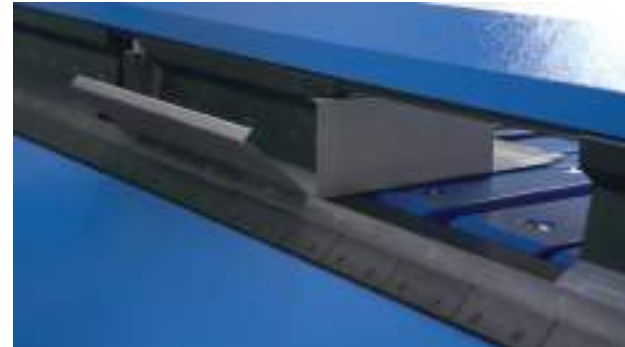

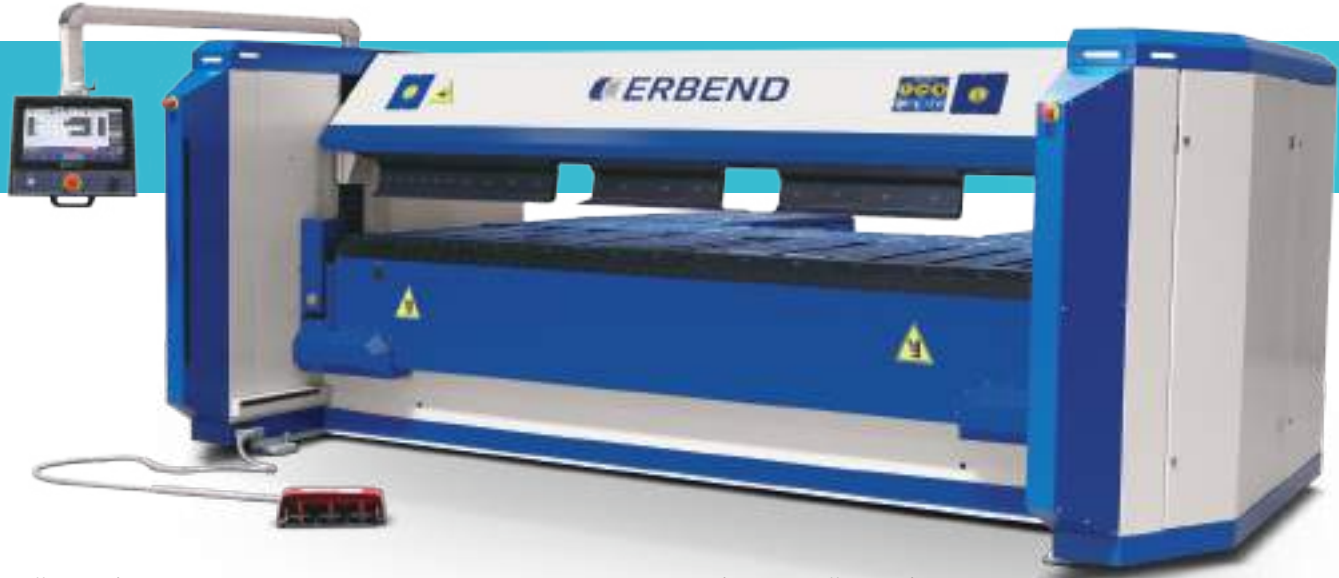

STANDART ÖZELLİKLER

- 350 mm açılma mesafeli kenetleme çenesi üzerinde 170 mm yüksekliğinde parçalı keçi ayağı kalıpları.
- 170 mm yüksekliğinde parçalı keçi ayağı kalıpları.
- 1500 mm servo arka dayama sistemi, dikdörtgen sac destek tablası ve solid dayama kolları.
- Daha yüksek klempleme kuvveti için çift motorlu kontrol ve vidalı mil sistemi.
- 15.6" mafsallı kol ve dokunmatik ekran üzerinde Erfold CNC kontrol yazılımı.
- 15 ve 40 mm genişlikte tek parça bükme kalıpları. (2 set)
- Manuel büküm çenesi yükseklik ayarı.
- Ön ışık bariyerleri.

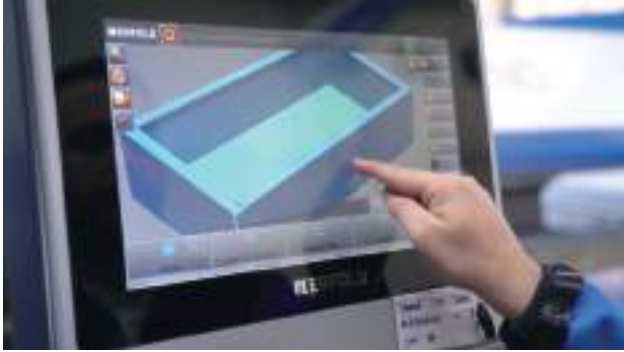

Easy 3D graphical programming even for complex parts.
Karmaşık parçalarda bile kolay 3 boyutlu grafik programlama.

OPSİYONEL ÖZELLİKLER

- 400 mm çene açılma mesafesi ve 200 mm yükseklikte parçalı kalıplara yükseltme.
- 2500 / 3200 / 4200 mm uzunlukta L / T / U şekilli sac tablalı arka dayama yükseltme.
- ERFOLD ADVANCED 2D/3D Cnc Grafik Kontrol.
- Servo motorlu büküm çenesi yükseklik ayarı.
- Pnömatik keçi ayağı kalıpları hızlı sıkma sistemi.
- Manuel bombeleme sistemi.
- Spatula tipi dayama kolları ve kanalsız tek parça alt kalıp.
- Parçalı alt veya bükme kalıpları.



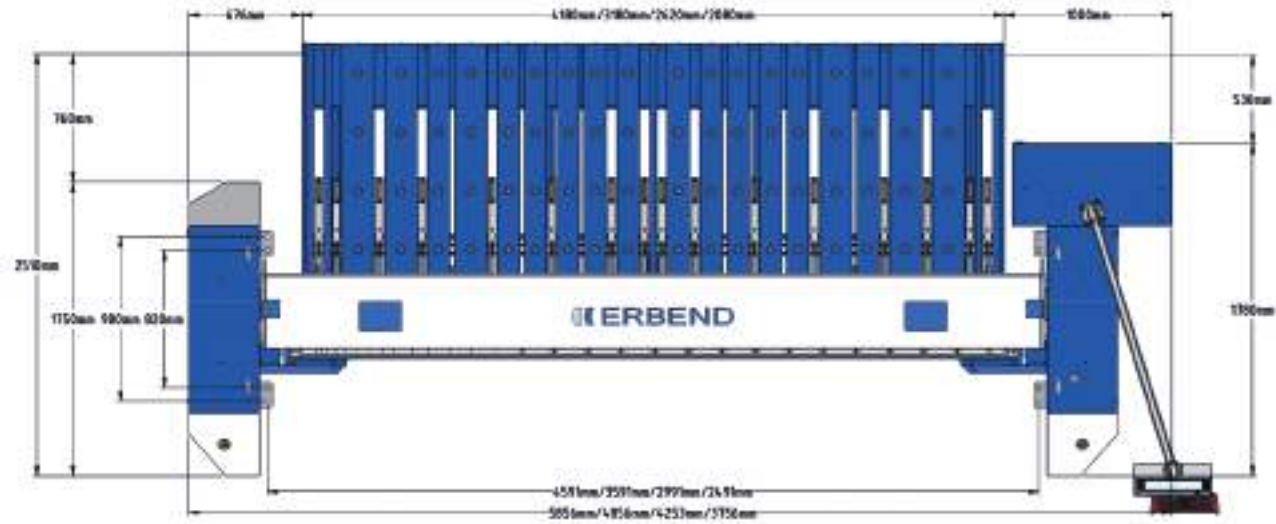

Model Model	Folding Length (mm) Sac Geniřliđi (mm)	Steel (mm) Çelik (mm)	Stainless (mm) Paslanmaz (mm)	Aluminium (mm) Alüminyum (mm)	Std machine loading dimensions (L/W/H) / Std makine yüklem ölçüleri G / U / Y	Weight (kg) Ađırlık (kg)
SFA 2040	2050	4	3	6	3600/2300/2400	6800
SFA 2535	2550	3,5	2,5	5	4100/2300/2400	7300
SFA 3230	3200	3	2	4	4700/2300/2400	8250
SFA 4225	4200	2,5	1,5	3,5	5700/2300/2400	9650

CNC Servo Combi Sheet Metal Folding Machine CNC Servo Kombi Caka Bükme Makinesi

MFA



Dual tool station rotating combi upper beam.
Çift kalıp istasyonlu döner combi üst çene.



Combi beam advantage is the ability to fold long profile parts and also box panel parts at the same time without changing tools.

Combi üst çene sayesinde hiç kalıp değişikliği yapmadan hem uzun profil parçaları hem de aynı zamanda kutu/ panel parçaların bükümü mümkündür.



STANDARD FEATURES

- Dual drive clamping beam with ball screw spindle system for more clamping power.
- 250 mm opening height on 180° rotating combi clamping beam with 2 tooling stations as 125 mm high segmented goat foot tools on station 1 and 30° single piece sharp nose tool on station 2.
- Solid lower beam with channels and 2 sets of single piece folding tools as 15 and 40 mm wide.
- Manual folding beam adjustment.
- ERFOLD BASIC CNC LBL control software on 15.6" touchscreen controller with swivel arm.
- 1500 mm servo back gauge system with pneumatic solid fingers and sheet support table with ball casters.
- Front light barriers.

STANDART ÖZELLİKLER

- Daha yüksek kleme kuvveti için çift motorlu kontrol ve vidalı mil sistemi.
- 250mm açılma mesafeli 180° dönebilen çift kalıp istasyonlu kenetleme çenesi üzerinde 125 mm yüksek parçalı keçi ayağı kalıpları ve 30° kısa keskin burun kalıp.
- Kanallı tek parça alt kalıp ve 2 set olarak 15 + 40 mm genişliğinde tek parça bükme kalıpları.
- Manuel büküm çenesi yükseklik ayarı.
- 15.6" mafsallı kol ve dokunmatik ekran üzerinde Erfold Basic cnc kontrol yazılımı.
- 1500 mm servo arka dayama sistemi, solid dayama kolları ve bilyalı sac destek tablası.
- Ön ışık bariyerleri.

OPTIONAL FEATURES

- 2500 / 3200 / 4200 mm servo backgauge system upgrade with L / T / U shape sheet support table options.
- ERFOLD ADVANCED 2D/3D cnc graphic control software.
- Servo folding beam adjustment.
- Manual crowning system.
- Pneumatic quick goatfoot tool clamping.
- Segmented bottom or folding tools.

OPSİYONEL ÖZELLİKLER

- 2500 / 3200 / 4200 mm uzunlukta L / T / U şekilli sac tablalı arka dayama yükseltme.
- ERFOLD ADVANCED 2D/3D cnc grafik kontrol yazılımı.
- Servo motorlu büküm çenesi yükseklik ayarı.
- Manuel bombeleme sistemi.
- Pnömatik keçi ayağı kalıbı hızlı sıkma sistemi.
- Parçalı alt veya bükme kalıpları.

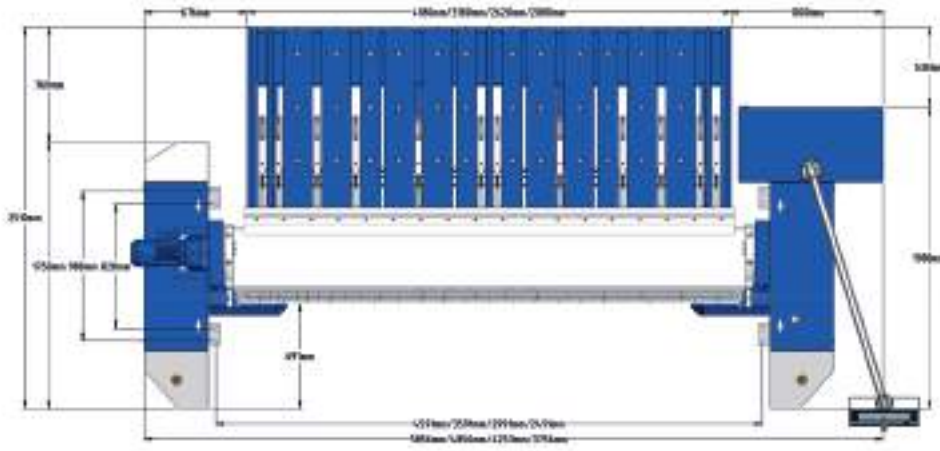
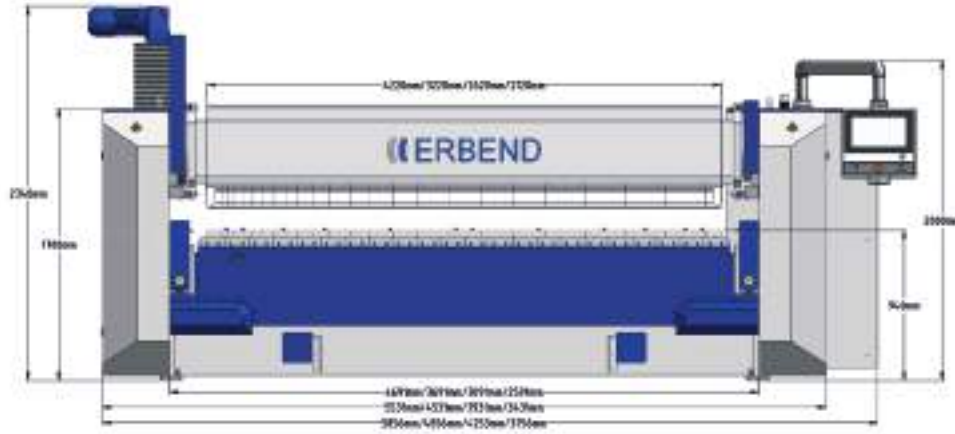

Model Model	Folding Length (mm) Sac Geniřliđi (mm)	Steel (mm) Çelik (mm)	Stainless (mm) Paslanmaz (mm)	Aluminium (mm) Alüminyum (mm)	Std machine loading dimensions (L/W/H) / Std makine yükleme ölçüleri G / U / Y	Weight (kg) Ađırlık (kg)
MFA 2040	2050	4	3	6	3600/2300/2300	6600
MFA 2545	2550	3.5	2.5	5	4100/2300/2300	7100
MFA 3230	3200	3	2	4	4700/2300/2300	8050
MFA 4225	4200	2.5	1.5	3.5	5700/2300/2300	9450

STANDARD FEATURES

- 200 mm opening height capacity on 180° rotating clamping beam with 2 tool stations as 100 mm high segmented goat foot tool and 20° single piece sharpnose tool.
- Eccentric upper beam power transmission system for rapid clamping/unclamping.
- Manual folding beam adjustment.
- 1000 mm servo backgauge system with feather grooves.
- 10 and 25 mm wide single piece folding tools as 2 sets.
- ERFOLD BASIC CNC LBL Cnc control software on 15.6" touchscreen controller with swivel arm.
- Solid lower beam tool without channels.
- Front light barriers.

OPTIONAL FEATURES

- 1500 mm servo backgauge system with rectangular sheet support table.
- 2500 / 3200 / 4200 mm servo backgauge system upgrade with L / T / U shape sheet support table options.
- ERFOLD ADVANCED 2D/3D CNC Graphic Control Software.
- Servo folding beam height adjustment.
- Omega geometry upgrade on lower and folding beam.
- Manual conical backgauge finger.
- Motorized conical backgauge system.
- Pneumatic goat foot tool quick clamping system.
- Manual crowning system.

STANDART ÖZELLİKLER

- 200 mm açılma mesafeli 180° dönebilen çift kalıp istasyonlu kenetleme çenesi üzerinde 100 mm parçalı kalıplar ve 20° tek parça keskin burun kalıp.
- Seri açma ve kapama için eksantrik üst çene güç aktarım sistemi.
- Manuel büküm çenesi yükseklik ayarı.
- 1000 mm servo arka dayama sistemi ve spatula tipi dayama kolları.
- 10 ve 25 mm genişlikte tek parça bükme kalıpları. (2 set)
- 15.6" mafsallı kol ve dokunmatik ekran üzerinde ERFOLD BASIC CNC LBL Cnc kontrol yazılımı.
- Tek parça kanalsız alt kalıp.
- Ön ışık bariyerleri.

OPSIYONEL ÖZELLİKLER

- 1500 mm servo arka dayama ve dikdörtgen sac destek tablası.
- 2500 / 3200 / 4200 mm uzunlukta L / T / U şekilli sac tablalı arka dayama yükseltme.
- ERFOLD ADVANCED 2D/3D Cnc grafik kontrol yazılımı.
- Servo motorlu büküm çenesi yükseklik ayarı.
- Alt çene ve bükme çenesi omega geometri yükseltmesi.
- Manuel konik arka dayama kolu.
- Motorlu konik arka dayama sistemi.
- Pnömatik keçi ayağı kalıpları hızlı sıkma sistemi.
- Manuel bombeleme sistemi.



Combi beam geometry provides mre clearance on both sides.

Kombi üst çene geometrisi çenenin her iki tarafında da daha fazla boş alan sağlar.



Dual tool station rotating
combi upper beam.
Çift kalıp istasyonlu döner
combi üst çene.

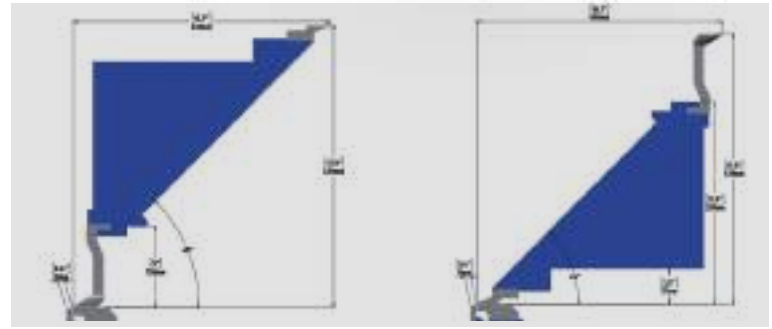

Thanks to the pressure combi beam and two sets of pressure tools, it is possible to process all materials and workpiece shapes.
Basınç kombi kirişi ve iki takım baskı aleti sayesinde tüm malzemeleri ve iş parçası şekillerini işlemek mümkündür.



Open or closed hemming / Açık ya da kapalı ezme

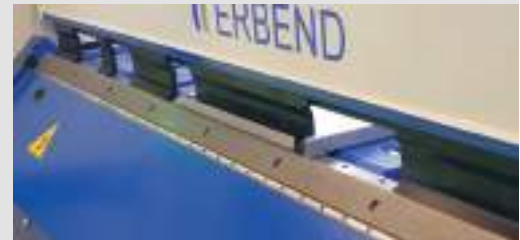

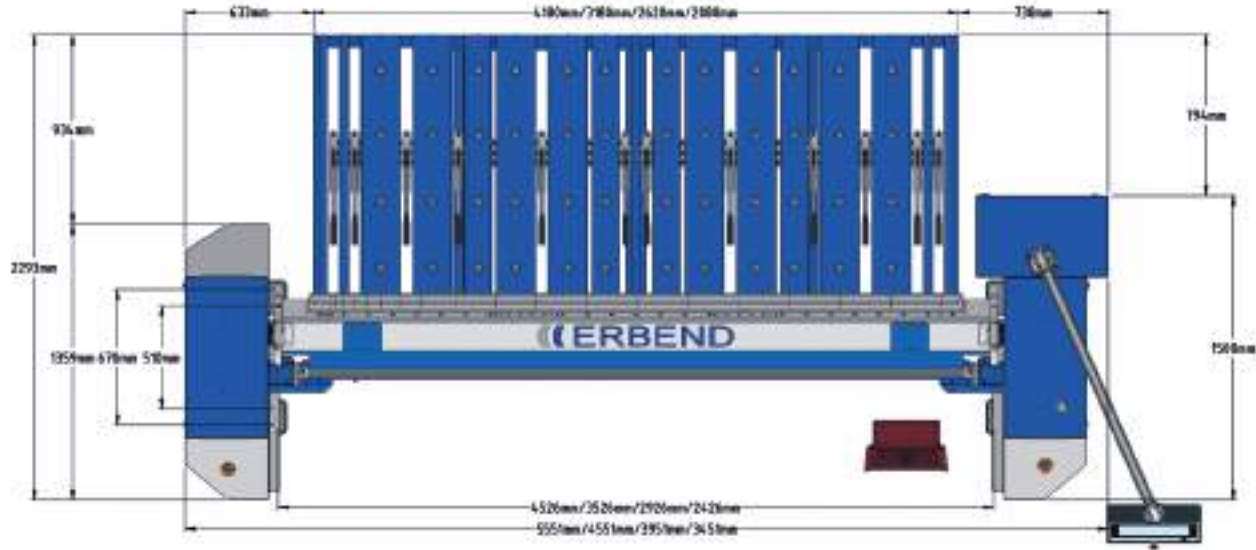

Model Model	Folding Length (mm) Sac Geniřliđi (mm)	Steel (mm) Çelik (mm)	Stainless (mm) Paslanmaz (mm)	Aluminium (mm) Alüminyum (mm)	Std machine loading dimensions (L/W/H) / Std makine yükleme ölçüleri G / U / Y	Weight (kg) Ağırlık (kg)
MFD 2525	2550	2.5	1.5	3.5	3830/2200/1900	4200
MFD 3220	3200	2	1.2	3	4450/2200/1900	4600
MFD 4215	4200	1.5	1	2	5450/2200/1900	5500

Manual Metal Folding Machine
Manuel Caka Bükme Makinesi

UFA



Model Model	Folding Length (mm) Sac Geniřliđi (mm)	Steel (mm) Çelik (mm)	Stainless (mm) Paslanmaz (mm)	Aluminium (mm) Alüminyum (mm)	Std machine loading dimensions (L/W/H) / Std makine yükleme ölçüleri G / U / Y	Weight (kg) Ađırlık (kg)
UFA 1015	1050	1.5	1	2.2	750/1300/1515	280
UFA 1212	1250	1.25	0.8	2	750/1500/1715	315

STANDARD FEATURES

- Vertical clamping with 200 mm stroke.
- Easy tool clamping system with specific Erbind design.
- All segmented tools are 42CrMo4 material, 60 HRC laser induction surface hardened and grinded.
- Bending angle stabilization system.
- Clamping beam stabilizer arm.
- Clamping beam stabilizer foot pedal.
- Easier clamping re-swivel thanks to special pressure springs.
- Easier folding re-swivel thanks to special return springs.
- 500 mm manual back gauge system.
- Tool, accessory cabinet holder.

STANDART ÖZELLİKLER

- 200 mm strok mesafesi ve salınım hareketli kenetleme çenesi.
- Hızlı kalıp değiştirebilmek için tasarlanmış, kolay kalıp sökme/ takma sistemi.
- Kenetleme çenesi parçalı keçi ayağı kalıpları: 42CrMo4 yüzey sertleştirilmiş malzemeden, yükseklik:100 mm, genişlik:100 mm, ayak derinliği:50 mm olarak kendi bünyemizde imal edilmektedir.
- Parçalı büküm çenesi kalıpları: 42CrMo4 yüzey sertleştirilmiş malzemeden, 15 mm derinlikte, kendi bünyemizde imal edilmektedir.
- Büküm açısı ayarı sabitleme sistemi.
- Üst/kenet çenesi sabitleme kol sistemi.
- Üst/kenet çenesi sabitleme pedal sistemi.
- Özel baskı yay sistemi sayesinde daha kolay üst çene salınımı.
- Özel geri esneme yay sistemi sayesinde daha kolay büküm çenesi salınımı.
- 500 mm manuel arka dayama.
- Kalıp ve malzeme dolabı.





STANDARD FEATURES

- 750 mm NC motorized back gauge system.
- 2 sides usable upper and lower blades.
- Back light barriers and finger protection cover in front side.
- Sliding front sheet support arms.
- Shadow light and cutting line enlightenment.

OPTIONAL FEATURES

- 1000 mm NC motorized back gauge system
- Side gauge extension to 2000 mm
- Variable angular cutting support
- Laser cutting line indicator
- Pneumatic sheet support as front or rear drop
- Blade set as spares
- Blank sheet wagon with wheels.

STANDART ÖZELLİKLER

- 750 mm NC motorlu dayama sistemi.
- Çift taraflı kullanılabilen alt ve üst bıçaklar.
- Arka ışık bariyerleri ve ön parmak koruma.
- Kayar ön sac destek kolları.
- Gölge teli ve kesim çizgisi aydınlatması.

OPSİYONEL ÖZELLİKLER

- 1000 mm NC motorlu dayama sistemi.
- 2000 mm e kadar yan dayama uzatma.
- Değişebilir açılı kesim desteği.
- Lazer kesim çizgi göstergesi.
- Öne veya arkaya düşürmeli pnömatik sac destek sistemi.
- Yedek parça bıçak seti.
- Tekerlekli taşıma arabası.

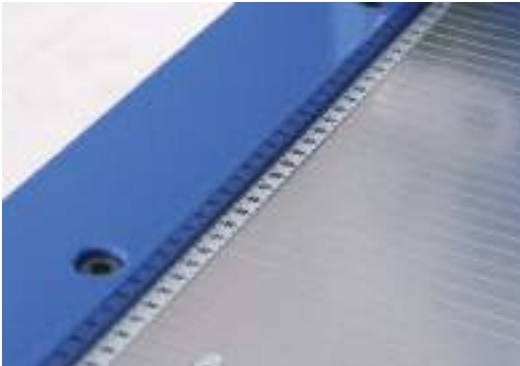

Model Model	Folding Length (mm) Sac Geniřliđi (mm)	Steel (mm) Çelik (mm)	Stain- less (mm) Pas- lanmaz (mm)	Aluminium (mm) Alüminyum (mm)	Std machine loading dimensions (L/W/H) Std makine yükleme ölçüleri G / U / Y	Weight (kg) Ağırlık (kg)
EMS 2525	2550	2.5	1.5	4	1700 / 3150 / 1300	2200
EMS 2540	2550	4	2.5	6	1700 / 3150 / 1300	2300
EMS 3220	3200	2	1.2	3	1700 / 3650 / 1300	3100
EMS 3240	3200	4	2.5	6	1700 / 3650 / 1300	3200
EMS 4015	4050	1.5	1	2	1700 / 4750 / 1600	3350





You can create new receipt by entering name,material type,sheet thickness and length, save,load pre-made receipt or delete existing receipt.

To programme the receipt you created, you can define unlimited number of steps and each step's bend type (angle,radius or hemming) tool station,backgauge position,folding angle,upper beam up/down positions, radius bending values and hemming values (open or closed)

Reçete adı, malzeme cinsi, kalınlığı ve genişliğini belirleyip yeni reçete adı oluşturabilir, sınırsız sayıda kaydedebilir, önceden oluşturduğunuz reçeteleri çağırabilir, düzenleyebilir ya da silebilirsiniz.

Oluşturduğunuz reçetede, sınırsız sayıda adım girişi yapıp, bu her bir adımın, kalıp istasyonunu, bükümdeki arka dayama pozisyonu, büküm açısı, üst çene inme ve kalkma değerlerini, büküm tipine göre radüs veya ezme değerlerini girerek adım programınızı yapabilirsiniz.



SETTINGS

This page requires authorization with password. You can define,import or edit your tools in the tool menu, you can create a bending database for auto angle correction against sheet springback according to the material type,thickness and length. You can also edit all machine's axis,driver,motor or accessory parameters from the parameters menu.

AYARLAR

Bu sayfa yetkilendirme içerir ve şifreyle ilgili bölümler açılabilir, kullandığınız kalıpları belirleyebilir, yeni kalıp tanımlayabilirsiniz, malzeme tipi,genişliği ve kalınlığına göre geri esneme veri tabanı oluşturabilirsiniz ve tüm bükümlerinizi için aktif hale getirebilirsiniz, parametre sayfasından da makinenin tüm eksen ve aksesuarlarıyla ilgili detaylı değişiklikleri yapabilirsiniz.

ERFOLD 2D/3D CNC Graphic Software is the ultimate cnc graphic controller software specifically designed for ERBEND motorized folding machines which provides a full and modern control capability to its user with various solutions and user friendly interface for any kind of folding operations.

- 15.6" or 22" tft panel capacitive touchscreen all-in one industrial pc controller on swivel arm.
- 16 GB hard disk space which allows you to save unlimited part or tool data.
- All main worldwide languages are supported

ERFOLD, pratik ve gelişmiş ara yüzü sayesinde, her türlü caka büküm operasyonunu kolayca tasarlayıp yapabileceğiniz, ERBEND motorlu caka büküm makineleri için özel olarak tasarlanmış, modern ve üst düzey bir grafik kontrol yazılımıdır.

- Mafsallı döner kol üzerinde 15.6" tft panelli kapasitif dokunmatik ekran kontrol ünitesi.
- 16 GB hard disk alanı sayesinde sınırsız sayıda parça veya kalıp datası saklama imkanı
- Tüm dünyadaki yaygın dilleri desteklemektedir.
- Standart olarak LBL (Satır programlama) versiyonu makina beraberinde verilmektedir. Sonrasında istendiği takdirde 2D veya 3D versiyona yükseltme uzaktan yapılabilir.

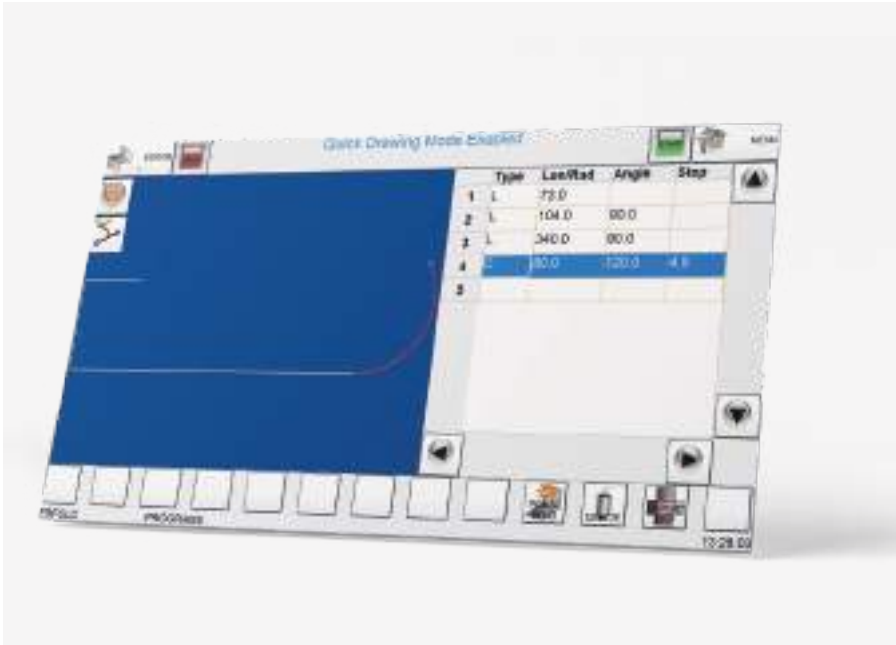

2D Editor:

You can create a new bending programme by drawing and design line by line and by giving required dimensions and visualize it in 2D view. You can create standard bends, radius bends or open/closed hemming bends.

2D Tasarım Modu:

Parçalarının şeklini önce elle çizebilir, sonra da her kısmını dilediğiniz gibi ölçülendirebilirsiniz. Normal büküm, radüs büküm ya da açık / kapalı ezme (ütüleme) tipinde bükümler tasarlayabilirsiniz.

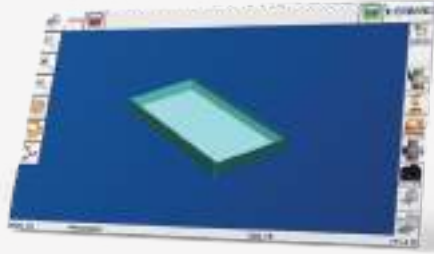

3D Editor:

(Only available in ERFOLD ADVANCED 3D) You can draw the part in 3D view or you can import your part as DXF /STEP/IGS file by importing over an offline pc software. You can create standart flange bendings or open / closed hemming bends.

3D Tasarım Modu:

(Yalnızca 3D versiyonda geçerlidir); Parçanızı 3 boyutlu olarak çizip ölçümlendirebilirsiniz ya da ofis bilgisayarınızdaki offline yazılıma DXF/STEP/IGS formatlarında import edip makine yazılımınıza aktarabilirsiniz.

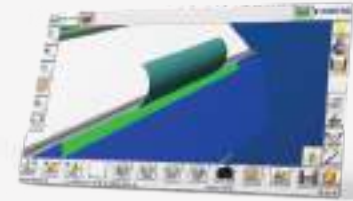
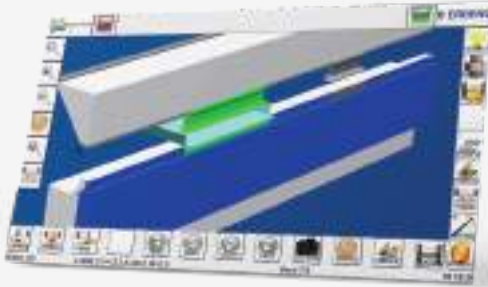

Simulation Mode:

You can simulate the bending scenario of the part and check if you have any collisions to decide to change the part dimensions, tool setup or bending sequence of the part if needed.

Simülasyon Modu:

Büküm öncesinde, bükümünüzü simüle ederek büküm senaryonuzun ilerlemesinin nasıl olacağını 3 boyutlu olarak görüntüleyebilir, gerekli olduğu takdirde büküm sıralaması, takım dizilimi veya parça ölçüsüne müdahale edebilirsiniz.

ERBEND TÜRKİYE

Kayapa OSB Mavi Cd. No:39 16280

Nilüfer / Bursa / Türkiye

Phn. : +90 224 441 73 50

E-Mail : info@erbend.com

www.erbend.com

[f](#) [Instagram](#) [YouTube](#) [in](#) / Erbendmakine



Catalogue : 2023
New Print : 01